

Datasheet ESRF-HF

MEMS Resistive Gas Flow Sensor

- State of the art performance due to MEMS resistive technology
- High accuracy
- 12 bit resolution
- Wide dynamic range (100:1)
- Low pressure drop
- Gas Flow sensor: up to 1500 l/min
- Temperature compensation: 0°C to +50°C
- Calibrated & temperature compensated analog output (4-20mA)
- Excellent long term stability
- Compact size
- 10Hz output rate
- 14 to 32V Power Supply



Product Summary

ES Systems has developed ESRF-HF, a family of insertion gas flow transmitters, based on the hot-film anemometer principle for mass gas flow measurements.

The ESRF-HF is a family of mass flow transmitters which enable fast and accurate measurements of gas flow over a wide dynamic range. Each transmitter integrates a MEMS flow sensor and readout electronics inside a housing with very small form factor made from stainless steel. The duty pressure of the flow transmitter is 11bar. All measurement data are fully calibrated, and temperature compensated on board, leading to a reduced temperature coefficient and high measurement accuracy.

The standard system provides analog signal output, with excellent repeatability and hysteresis combined with good resolution. Calibration gas is air, but other non-aggressive gases can be also available upon request.

The compact size of the ESRF-HF flow transmitters combined with the ruggedized stainless-steel housing makes them ideal for use in industrial applications within confined spaces. For easier handling and mounting, a series of in-line pipe adaptors (Ø20, Ø25, Ø32) is also available upon request.

Typical Applications

- Central gas medical systems
- Process control
- Industrial applications
- Pneumatic components
- General instrumentation

1. Total Error Band

Total Error Band (TEB) is a single specification that includes all possible sources of error in a gas flow measurement. TEB should not be confused with accuracy, which is actually a component of TEB. TEB is the worst error that the sensor could experience. The TEB specification on a datasheet may be confusing. ES Systems uses the TEB specification in its datasheet because it is the most comprehensive measurement of a sensor's true accuracy. ES Systems also provides the accuracy specification in order to provide a common comparison with competitors' literature that does not use the TEB specification.

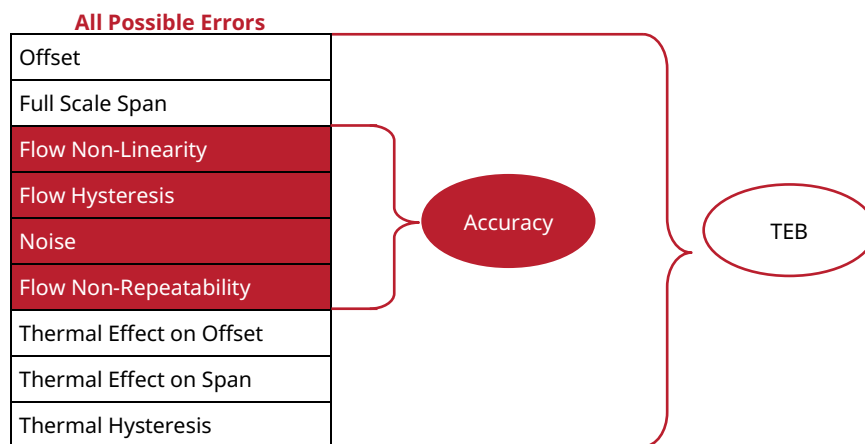

The figure below, illustrates the accuracy as well as the total error of the flow measurement of ESRF-HF sensors.

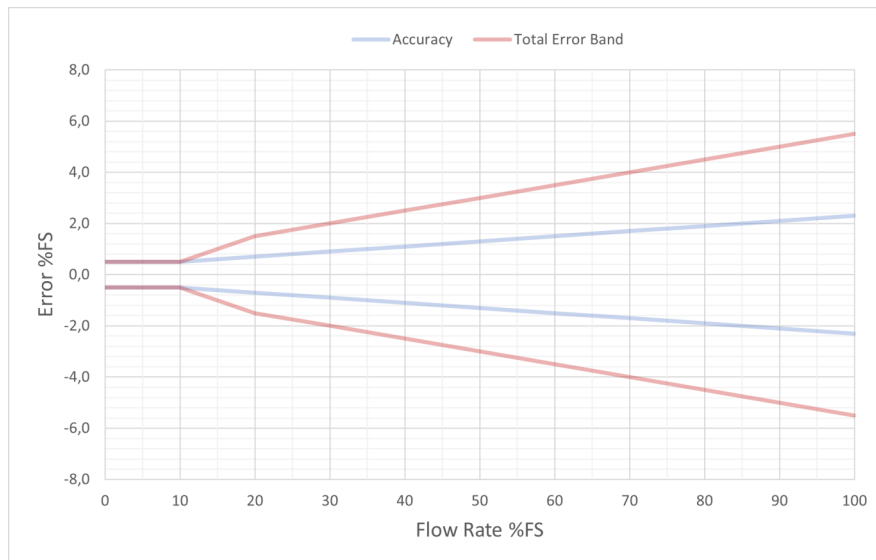

Accuracy Performance

- 0% FS to 10%FS = ±0.5%FS
- 10%FS to 100%FS = ±2.0% RD + 0.3%FS

Total Error Band Performance

- 0% FS to 10%FS = ±0.5%FS
- 10%FS to 100%FS = ±5.0% RD + 0.5%FS



2. Absolute Maximum Ratings¹

Characteristic	Min.	Max.	Unit
Supply voltage (V_{supply})	14	32	Vdc
Voltage on any pin	-0.3	6.5	V
Current on any pin	-	2	mA
Burst pressure	-	13	barg
Storage temperature	-40[-40]	+85[+185]	°C[°F]
Maximum flow applied	-2200	2200	ln/min

¹ Absolute maximum ratings are the extreme limits the device will withstand without damage. The electrical and performance characteristics are not guaranteed as the maximum limits are approached, nor will the device necessarily operate as specified at absolute maximum ratings. Prolonged operation at absolute maximum ratings will degrade the device performance

CAUTION

IMPROPER USE

Do not use these products to sense liquid flow.
Failure to comply with the instructions may result in product damage.

CAUTION

PRODUCT DAMAGE

Do not disassemble these products.
Failure to comply with the instructions may result in product damage.

3. Operating Specifications

Characteristic	Min.	Typ.	Max.	Unit
Supply voltage (V_{supply}) ¹	14	24	32	V
Supply current	-	60	-	mA
Output	Analog (4-20mA)			-
Start-up time ²	-	500	-	msec
Operating temp. range	-40[-40]	-	+85[+185]	°C[°F]
Compensated temp range	0[+32]	-	+50[+122]	°C[°F]
Relative humidity (non-condensing)	0	-	95	% RH
Compatible gases	Inert non aggressive gases			-
Gas conversion factor				
Air to O ₂	-	1.0190	-	-
Air to N ₂	-	0.9997	-	-
Update rate	100	-	-	ms
Analog output loading				
Sink	-	-	10	mA
Source			20	

¹The sensor is not reverse polarity protected. Incorrect application of supply voltage or ground to the wrong pin may cause electrical failure

²After 95% of V_{supply} reached

4. Flow Sensor Specifications

Characteristic	Absolute			Unit
	Min.	Typ.	Max.	
Flow direction	Unidirectional			-
Full scale ranges	100, 150, 250, 300, 500, 600, 700, 800, 1000, 1200, 1500			ln/min ¹
Flow cut ²	1.0			%FS ³
Max measured flow	-	-	1500	ln/min
Calibration gas	Clean, Dry Air ⁴			-
Operating temp. range ⁵	-40[-40]	-	+85[+185]	°C[°F]
Compensated temp range ⁶	0[+32]	-	+50[+122]	°C[°F]
Operating pressure	1.0	-	10	bara
Proof pressure	-	-	11	bara
Effective resolution	12	-	-	bits
Response time	-	100	-	msec
Total error band ⁷ (<10%FS)	-	±0.5	-	%FS
Total error band (>10%FS)	-	±5.0+0.5	-	%RD ⁸ +%FS
Accuracy ⁹ (<10%FS)	-	±0.5	-	%FS
Accuracy (>10%FS)	-	±2.0+0.3	-	%RD+%FS
Orientation sensitivity ¹⁰	-	0.001	-	%FS/ ^o
Long term stability ¹¹	-	-	±0.1	%FSS ¹²

¹ In normal liters per minute at 0°C and 1013 mbar

² Flow measured below this point will always indicate 0 ln/min

³ % of the full scale

⁴ Other, non-aggressive, gases available upon request

⁵ The temperature range over which the sensor will produce an output proportional to flow (Non condensing humidity)

⁶ The temperature range over which the sensor will produce an output proportional to flow within the specified performance limits. Note that for valid datasheet values, ambient and gas temperatures must be the same

⁷ The maximum deviation from ideal transfer function over the entire compensated temperature and flow range. Includes all errors due to offset, full scale span, accuracy, thermal effect on offset, thermal effect on span and thermal hysteresis

⁸ % of the reading value

⁹ The maximum deviation in output from a Best Fit Straight Line (BFSL) fitted to the output measured over the flow range at 21°C [69.8°F]. Includes all errors due to flow non-linearity, flow hysteresis, non-repeatability and noise

¹⁰ Added measurement error due to orientation deviation from the optimal (calibration) position

¹¹ Accelerated Life Test Profile: 100hours at 90°C

¹² Full Scale Span (FSS): The algebraic difference between the output signal measured at the maximum (U_{max}) and the minimum (U_{min}) limits of the flow range

5. Flow Range Specifications (ln/min)

Flow Range	Flow Range		Unit	Pressure Drop @ FS DN20	Pressure Drop @ FS DN25	Pressure Drop @ FS DN32	Unit
	U _{min} ¹	U _{max}					
0100NL	1	100	ln/min	0.141	0.045	0.016	mbar
0150NL	1.5	150	ln/min	0.293	0.08	0.044	mbar
0250NL	2.5	250	ln/min	0.73	0.195	0.103	mbar
0300NL	3	300	ln/min	1.028	0.28	0.135	mbar
0500NL	5	500	ln/min	2.67	0.71	0.349	mbar
0600NL	6	600	ln/min	3.865	0.98	0.49	mbar
0700NL	4.7	700	ln/min	5.01	1.28	0.661	mbar
0800NL	5.3	800	ln/min	6.58	1.666	0.874	mbar
1000NL	6.7	1000	ln/min	10.68	2.506	1.33	mbar
1200NL	8	1200	ln/min	15.57	3.662	1.95	mbar
1500NL	15	1500	ln/min	24.8	5.707	3.12	mbar

¹ Flows below U_{min} will always indicate 0 ln/min

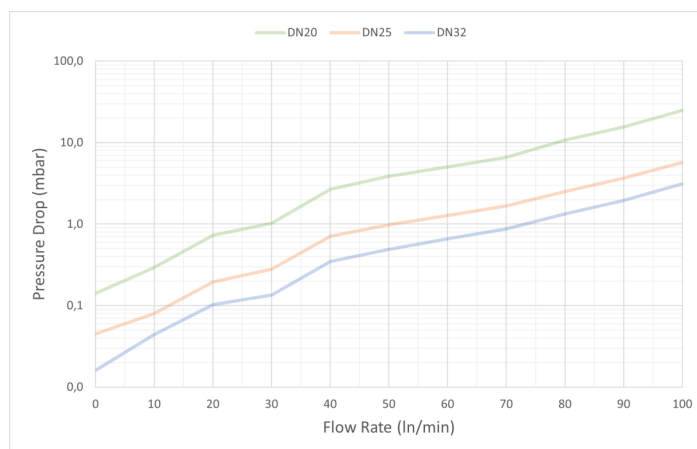

6. Environmental Specifications

Characteristic	Parameter
Wetted materials degree of protection	IEC IP40 (excluding tubing sections)
Vibration	15g, 10Hz to 2 kHz
Shock	100g, 6ms duration
ESD	ESD IEC6100-4-2 air discharge up to 8 kV, or direct contact discharge up to 4 kV
EMC/EMI	level 3 from 80 MHz to 1000 MHz per IEC61000-4-3, 1m shielded cable with 3cm exposed leads at connector.
Life ¹	1 million flow cycles minimum

¹ Life may vary depending on specific application in which the sensor is used

7. Analog Interface

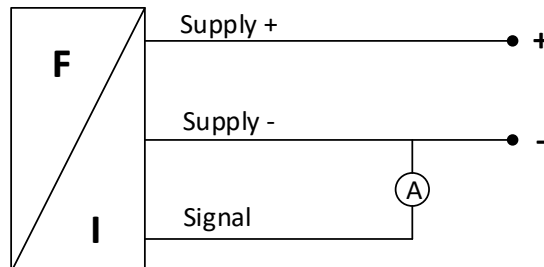

ESRF-HF sensors feature an analog current output (4-20mA), which allows for the readout of flow in an analog way by means of a data acquisition system (PLC) or a multimeter. The current to flow conversion formula is shown below. Flow is represented in l/min.

$$Flow = \frac{(Current_{Measured} - 4mA)}{16mA} \times Full\ Scale\ Flow$$

8. Wetted Materials¹

Component	Flow Port
Ports and covers	Stainless steel 316, Gold, Si, SiN, SiO _x , epoxy, silicon rubber, FR4, polyurethane
Housing	Stainless steel 316
Substrate	Gold, FR4
Adhesives	Epoxy
Weight	
Sensor	151g
Sensor + DN20 adapter	979g
Sensor + DN25 adapter	1223g
Sensor + DN32 adapter	1673g
Directives compliance	RoHS, WEEE

¹ Contact ESS Customer Service for detailed material information

9. Pinout

Output	White	Blue	Brown	Grey	Pink	Green	Yellow
Analog	Output	GND	VDD	NC	NC	NC	NC

10. Inlet - Outlet Flow Conditions

The ESRF-HF series sensors are calibrated in a horizontal position. The sensor requires at least $20 \times \varnothing$ of laminarizing pipe length in the flow inlet and another $20 \times \varnothing$ in the outlet. ESRF-HF series sensors are calibrated using DN20, DN25 or DN32 sensor adapters. For optimal performance, the diameter of the inlet and outlet flow pipes should be as close to the calibration diameter as possible.

11. Mechanical Drawings (mm)

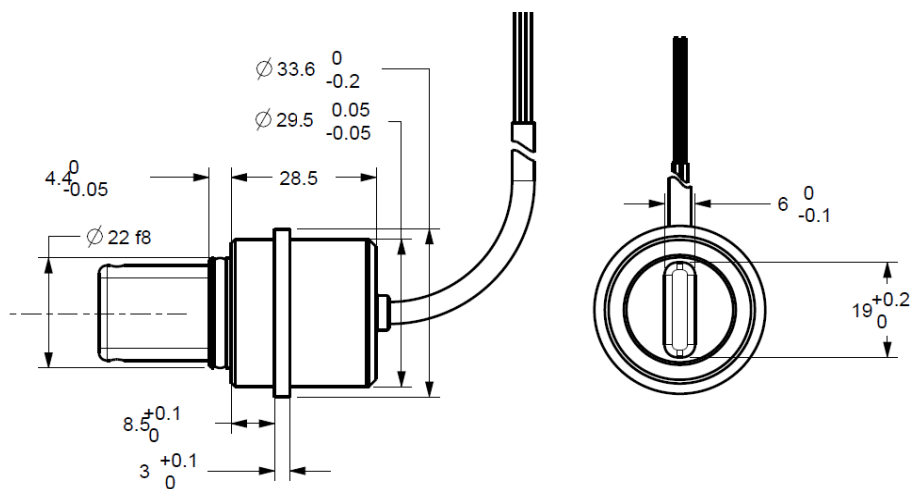

12. Sensor Adapters

ES Systems provides a series of in-line pipe adapters for ease of mounting and handling. The sensor adapters are manufactured with brass or stainless steel material.

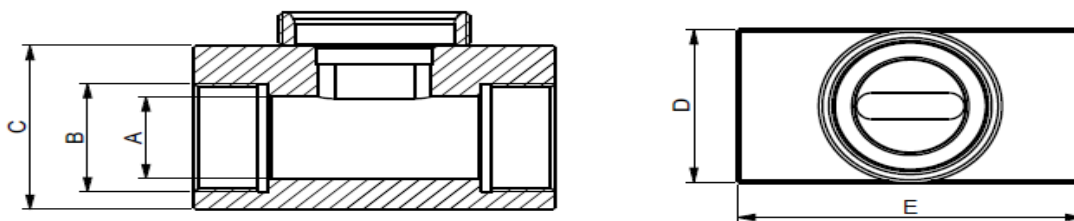

Type	A (mm)	B (inch)	C (mm)	D (mm)	E (mm)
DN20	20	3/4 BSP	40	36	68
DN25	25	1 BSP	42.5	40	78
DN32	32	1 1/4 BSP	46	48	88

13. Ordering Information

ESRF-HF-NNNNNN-NN-NN-NN-NN

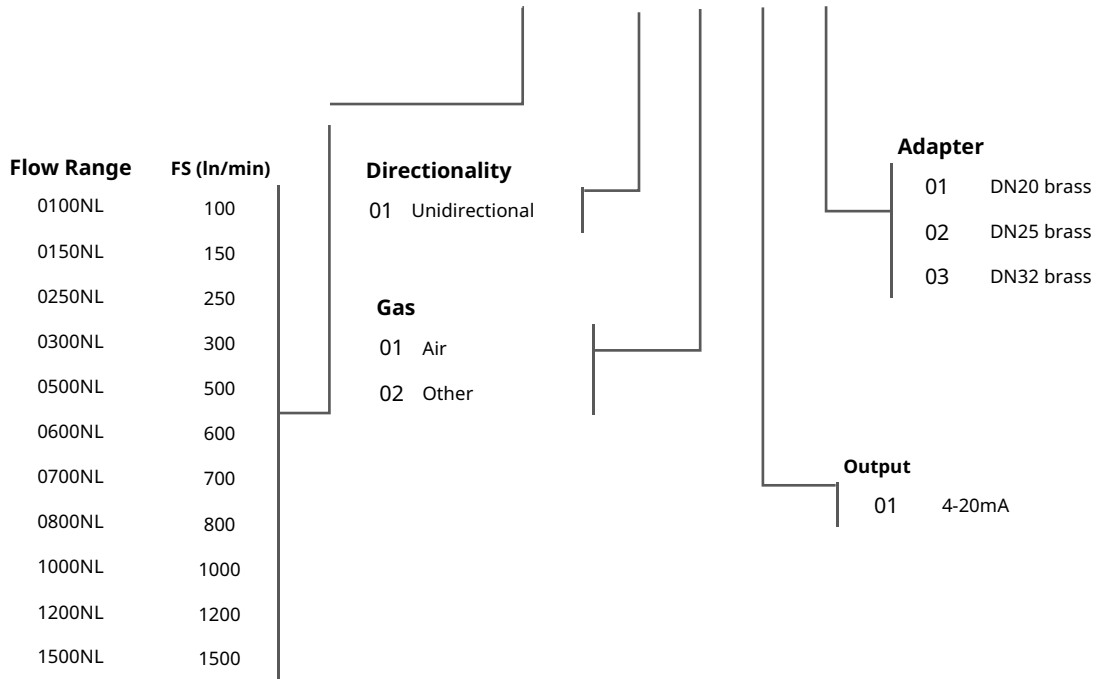

Important Notes

PERSONAL INJURY

DO NOT USE these products as safety or emergency stop devices, or in any other application where failure of the product could result in personal injury.

Failure to comply with these instructions could result in death or serious injury.

WARRANTY

ES Systems warrants this Product to be free of defects in materials and workmanship for a period of one (1) year from the date of purchase.

Upon examination by ES Systems, if the unit is found to be defective it will be repaired or replaced at no charge. ES Systems' WARRANTY does not apply to defects resulting from any action of the purchaser, including but not limited to mishandling, improper interfacing, operation outside of design limits, improper repair, or unauthorized modification. This WARRANTY is VOID if the unit shows evidence of having been tampered with or shows evidence of being damaged as a result of excessive corrosion; or current, heat, moisture or vibration; improper specification; misapplication; misuse or other operating conditions outside of ES Systems' control. Components which wear are not warranted.

ES Systems neither assumes responsibility for any omissions or errors nor assumes liability for any damages that result from the use of its Product in accordance with information provided by ES Systems, either verbal or written. ES Systems warrants only that the parts manufactured by it will be as specified and free of defects.

ES SYSTEMS MAKES NO OTHER WARRANTIES OR REPRESENTATIONS OF ANY KIND WHATSOEVER, EXPRESSED OR IMPLIED, EXCEPT THAT OF TITLE, AND ALL IMPLIED WARRANTIES INCLUDING ANY WARRANTY OF MERCHANTABILITY AND FITNESS FOR A PARTICULAR PURPOSE ARE HEREBY DISCLAIMED.

No representative of ES Systems is authorized to extend this Warranty or to change it in any manner whatsoever.

No warranty applies to any party other than the original Customer. The remedies of the Customer set forth herein are exclusive and the total liability of ES Systems with respect to this order, whether based on contract, warranty, negligence, indemnification, strict liability or otherwise, shall not exceed the purchase price of the component upon which liability is based.

In no event shall ES Systems be liable for consequential, incidental or special damages.

Specifications may change without notice. The information supplied is believed to be accurate and reliable as of this issue; however, ES Systems assumes no responsibility for its use.

Contact Information

ES Systems S.A.

Head Office:

7, Stratigi St., GR-154 51
Neo Psychico, Greece
Tel: (+30) 210 672 8610,
Fax (+30) 210 672 8624

Factory:

57, I.Metaxa str., GR-194 41
Koropi, Greece
Tel: (+30) 216 2000 500,
Fax (+30) 216 2000 555